

# TC73 and TC78 Accessories Guide

The ultra-rugged mobile computer re-imagined for the new age of mobility

Revised August 2024



<b>I.</b>	<b>Accessories that POWER devices</b>	
<b>1</b>	<b>Cradles</b>	
1.1	<a href="#">Single-slot cradles</a>	3
1.2	<a href="#">Multi-slot cradles</a>	4
1.3	<a href="#">Cradle cups and shims</a>	5
1.4	<a href="#">Zebra’s intelligent cabinet portfolio</a>	6
1.5	<a href="#">Mounting options for chargers</a>	7
<b>2</b>	<b>Batteries</b>	
2.1	<a href="#">Spare Li-ion batteries with BLE Beacon</a>	7
2.2	<a href="#">Spare Li-ion batteries</a>	8
2.3	<a href="#">Spare battery chargers</a>	9
<b>3</b>	<b>Power supply, cables, and adapters</b>	
3.1	<a href="#">Power supply and cable matrix</a>	10
3.2	<a href="#">Country-specific AC line cords</a>	12
<b>4</b>	<b><a href="#">Vehicle chargers and accessories</a></b>	14
<b>II.</b>	<b>Accessories that ENABLE productivity solutions</b>	
<b>5</b>	<b><a href="#">Vehicle holders and mounts</a></b>	15
<b>6</b>	<b>Headsets</b>	
6.1	<a href="#">Wireless headsets and accessories for voice-directed picking</a>	16
6.2	<a href="#">Wired headsets and accessories for Workforce Connect</a>	16
<b>7</b>	<a href="#">Hands strap, stylus and tether</a>	17
<b>8</b>	<b>Trigger handles</b>	
8.1	<a href="#">Electronic trigger handles and accessories</a>	18
<b>III.</b>	<b>Accessories that PROTECT devices</b>	
<b>9</b>	<b><a href="#">Soft holster and screen protectors</a></b>	19
<b>IV.</b>	<b><a href="#">TC73 / TC78 Workstation connect cradle</a></b>	20
<b>V.</b>	<b>Third Party Accessories for TC73/78</b>	
<b>10</b>	<b><a href="#">3<sup>rd</sup> party vehicle cradles</a></b>	21

## Single-slot cradles



### Single-slot charger kit

SKU# CRD-NGTC7-2SC1B

Single-slot charge-only ShareCradle kit. Charges a single TC73 / TC78 device and its spare Li-ion battery.

- Device with standard battery charges from 0–80% in about 1½ hours.
- Includes: Power supply SKU# PWR-BGA12V50W0WW, DC cable SKU# CBL-DC-388A1-01, and shims SKU# SHIM-CRD-NGTC7.
- Sold separately: Country-specific AC line cord ([listed later in this document](#)).



### Single-slot USB / Ethernet capable charger kit

SKU# CRD-NGTC7-2SE1B

Single-slot USB communication / ethernet capable charger ShareCradle kit. Charges a single TC73 / TC78 device and its spare Li-ion battery.

- Device with standard battery charges from 0–80% in about 1½ hours.
- Includes: Power supply SKU# PWR-BGA12V50W0WW and DC cable SKU# CBL-DC-388A1-01, and shims SKU# SHIM-CRD-NGTC7.
- Sold separately: Country-specific AC line cord ([listed later in this document](#)), micro-USB cable SKU# 25-124330-01R for USB communication, and USB to Ethernet module kit SKU# MOD-MT2-EU1-01



### USB to Ethernet module

SKU# MOD-MT2-EU1-01

Connects single-slot charge/USB charger to a local area network via Ethernet over USB.

- 10 / 100 / 1000 Mbps speed with LEDs on module to indicate connectivity and speed.
- Mechanical switch to choose micro-USB port or RJ45 Ethernet.



### USB to Ethernet module kit

SKU# KT-TC51-ETH1-01

Connects single-slot charge / USB charger to a local area network via Ethernet over USB.

- 10 / 100 / 1000 Mbps speed with LEDs on module to indicate connectivity and speed.
- Mechanical switch to choose micro-USB port or RJ45 Ethernet.
- Includes: USB-Ethernet Module SKU# MOD-MT2-EU1-01 and support bracket SKU# BRKT-TC51-ENET1-01.

## Multi-slot cradles



### Five-slot charger kit

SKU# CRD-NGTC7-5SC5D

Charge-only ShareCradle kit to charge five TC73 / TC78 devices.

- Can be mounted in a standard 19-inch rack system using mounting bracket [SKU# BRKT-SCRD-SMRK-01](#).
- Device with standard battery charges from 0–80% in about 1½ hours.
- Includes: Power supply [SKU# PWR-BGA12V108W0WW](#), DC cable [SKU# CBL-DC-381A1-01](#), and 5-pack of shims [SKU# SHIM-CRD-NGTC7](#)
- Sold separately: Country-specific AC line cord ([listed later in this document](#)).



### Five-slot Ethernet charger kit

SKU# CRD-NGTC7-5SE5D

Five-slot charge / Ethernet ShareCradle kit. Charges five TC73 / TC78 devices with network speeds of up to 1 Gbps.

- Device with standard battery charges from 0–80% in about 1½ hours.
- Includes: Power supply [SKU# PWR-BGA12V108W0WW](#), DC cable [SKU# CBL-DC-381A1-01](#) and 5-pack of shims [SKU# SHIM-CRD-NGTC7](#)
- Sold separately: Country-specific AC line cord ([listed later in this document](#)).



### Five-slot charger kit

SKU# CRD-NGTC7-5SC4B

Charge-only ShareCradle kit to charge four TC73 / TC78 devices and four spare Li-ion batteries.

- Can be mounted in a standard 19-inch rack system using mounting bracket [SKU# BRKT-SCRD-SMRK-01](#).
- Device with standard battery charges from 0–80% in about 1½ hours.
- Includes: Power supply [SKU# PWR-BGA12V108W0WW](#), DC cable [SKU# CBL-DC-381A1-01](#), and 4-pack of shims [SKU# SHIM-CRD-NGTC7](#)
- Sold separately: Country-specific AC line cord ([listed later in this document](#))

## Cradle cups and shims



### Device cradle cup replacement kit

SKU# CRDCUP-NGTC7-01

One TC73 / TC78 device cradle cup replacement kit. Can be used to replace a TC7x series device cup on ShareCradle when upgrading to TC73 / TC78.

- Includes: Shims SKU# SHIM-CRD-NGTC7.
- Also available as a 5-pack — 5 device cradle cups and 5 inserts/shims — SKU# CRDCUP-NGTC7-05.



### Charge and communication device cradle cup replacement kit

SKU# CRDCUP-NGTC7ETH-01

One TC73 / TC78 charge and USB / Ethernet connection device cradle cup replacement kit with two inserts/shims.

- Can be used to replace a TC7x series device cup on ShareCradle when upgrading to TC73 / TC78.
- Includes: Shims SKU# SHIM-CRD-NGTC7
- Also available as a 5-pack — 5 device cradle cups and 10 inserts/shims — SKU# CRDCUP-NGTC7ETH-05.



### Device cradle cup inserts / shims replacement

SKU# SHIM-CRD-NGTC7

One replacement cradle insert / shims

- Includes: Two inserts / shims — one for device without rugged boot, and another for device with rugged boot.

## Zebra's intelligent cabinet portfolio

Optimize enterprise mobile device storage and management

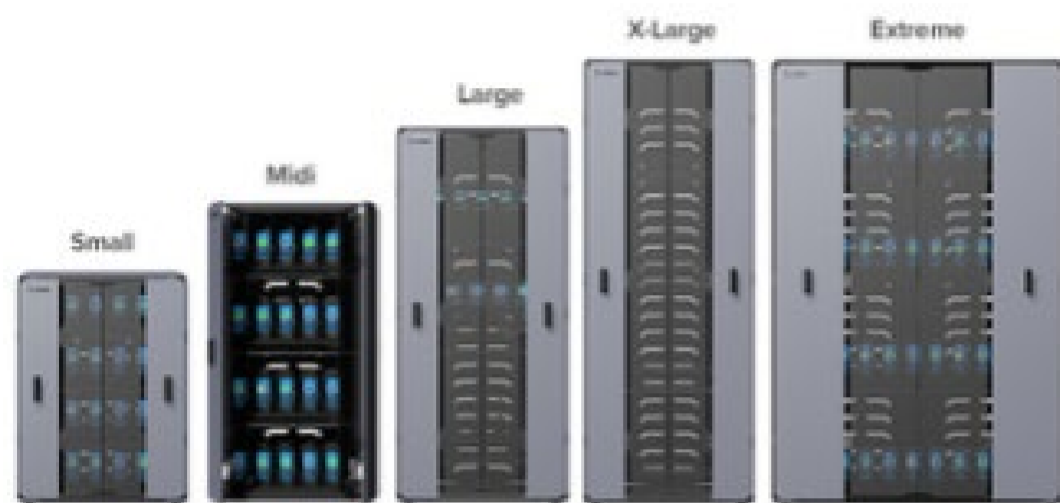

### Intelligent Cabinets\*

Easily secure, store, charge and handle checkout for Zebra mobile devices.

- Five cabinet sizes to accommodate between 20 and 100 devices
- Enhanced security options
- All-inclusive design includes built-in power supply
- Open leaf design for passive cooling through natural air flow

### Cradle Locks

Easily add a layer of physical security in Intelligent Cabinets and racks with Zebra's cradle locks. Available for Zebra's HC2x, HC5x, TC2x, TC5x and TC7x mobile computers, these mechanical locks physically prevent the removal of devices by any unauthorized personnel, increasing device security and reducing the number of lost or stolen devices.

- Mechanical locking for security and accountability
- Compatible with Zebra's Intelligent Racks and Cabinets.
- Battery charge status

### Open Racks

Traditional open racks offer a durable industrial design

- A choice of single- or double-sided rack to meet capacity needs
- A choice of wheels to easily move the racks or feet to create stationary racks
- Offers integrated security options including cradle locks with PIN access

*\*Intelligent Cabinets are not be available in all regions.*

Refer to [Zebra Solutions Pathway](#) for detailed product information, product SKUs and pricing.

[Back to Table of Contents](#)

## Mounting options for chargers



### Rack mounting for space optimization

Optimize available space by mounting any set of five-slot chargers for TC7X on a standard, 19-inch server rack.

- Ideal for customers that have several devices per location.
- Compatible with all five-slot chargers



### Mounting bracket

SKU# BRKT-SCRD-SMRK-01

Use five-slot ShareCradle mounting bracket to attach five-slot TC7X cradles to the wall or mount on a 19-inch server rack.

- Offers cable routing slots and removable tray that stores / conceals power supply.
- Adjustable orientations:
  - 25° angle for high-density (five-slot chargers).
  - Horizontal (single-slot or four-slot spare Li-ion charger).

## Spare Li-ion batteries



### BLE battery with PowerPrecision Plus

SKU# BTRY-NGTC5TC7-44MABLE-01

Standard capacity 4,680 mAh battery with PowerPrecision Plus and BLE beacon.

- BLE beacon allows device with this battery to be located even if powered off using [Zebra Device Tracker](#).
- Premium-grade battery cells with longer lifecycle and tested to meet rigorous controls and standards.
- Obtain advanced battery state of health information including charge level and battery age based on usage patterns.
- Sold separately: Zebra Device Tracker licenses for either 1-year SKU# SW-BLE-DT-SP-1YR or 3-years SKU# SW-BLE-DT-SP-3YR.



### Standard battery with PowerPrecision Plus

SKU# BTRY-NGTC5TC7-44MA-01

- Robust housing for optimal performance and durability.
- Battery state of health features.

[Back to Table of Contents](#)

## Spare Li-ion batteries



### Extended capacity battery with PowerPrecision Plus

SKU# BTRY-NGTC5TC7-66MA-01

Extended capacity 7,000 mAh battery with PowerPrecision Plus.

- Premium-grade battery cells with longer lifecycle and tested to meet rigorous controls and standards.
- Obtain advanced battery state of health information including charge level and battery age based on usage patterns.



### Wireless charging battery with PowerPrecision Plus

SKU# BTRY-NGTC5TC7-44MAWC-01

TC78 Standard capacity 4,680 mAh battery with Wireless charging and PowerPrecision Plus.

- Premium-grade battery cells with longer lifecycle and tested to meet rigorous controls and standards.
- Obtain advanced battery state of health information including charge level and battery age based on usage patterns.
- Works great with TC78 wireless charging vehicle cradle  
SKU# CRD-TC78-WCVC-01.

Compatibility	
TC73	No
TC78	Yes



### Standard battery with PowerPrecision Plus and Payment Support

SKU# BTRY-NGTC5TC7-PYMT

Standard capacity 4,680 mAh battery with PowerPrecision Plus and Payment support.

- Battery includes slot for integration with PD20 payment device.
- Premium-grade battery cells with longer lifecycle and tested to meet rigorous controls and standards.
- Obtain advanced battery state of health information including charge level and battery age based on usage patterns.



## Spare Battery Charger



### Battery charger

SKU# SAC-NGTC5TC7-4SCHG

Spare battery charger to charge any four spare Li-ion batteries.

- Standard capacity 4,400 mAh batteries charge from 0–90% in about 4 hours.
- Sold separately: Power Supply SKU# [PWR-BGA12V50W0WW](#), DC Cable SKU# [CBL-DC-388A1-01](#) and Country-specific AC Line cord ([listed later in this document](#)).



### Battery charger kit

SKU# SAC-NGTC5TC7-4SCHG-01

Spare battery charger to charge any four spare Li-ion batteries.

- Standard capacity 4,680 mAh batteries charge from 0–90% in about 4 hours.
- Includes: : Power Supply SKU# [PWR-BGA12V50W0WW](#), DC Cable SKU# [CBL-DC-388A1-01](#)
- Sold separately: Country-specific AC Line cord ([listed later in this document](#)).



### Four-slot battery charger conversion kit

SKU# BTRCUP-NGTC5TC7-01

One replacement four-slot battery charger

- Converts legacy TC5x four-slot battery charger or a multi-slot ShareCradle with spare battery Charger

## Power supply, cables, and adapters

### Power supply and cable matrix

SKU#	Description	Note
<a href="#">PWR-BGA12V108W0WW</a>	Level VI AC/DC power supply brick. AC Input: 100–240V, 2.8A. DC Output: 12V, 9A, 108W.	Included in:
<a href="#">CBL-DC-381A1-01</a>	DC line cord for running multi-slot cradles from a single Level VI power supply.	<ul style="list-style-type: none"> <li>• CRD-NGTC7-5SC5D</li> <li>• CRD-NGTC7-5SE5D</li> <li>• CRD-NGTC7-5SC4B</li> </ul>
<a href="#">PWR-BGA12V50W0WW</a>	Level VI AC/DC power supply brick. AC Input: 100-240V, 2.4A. DC Output: 12V, 4.16A, 50W.	Included in:
<a href="#">CBL-DC-388A1-01</a>	DC line cord for running single-slot cradles or battery chargers from a single Level VI power supply.	<ul style="list-style-type: none"> <li>• CRD-NGTC7-2SC1B</li> <li>• CRD-NGTC7-2SE1B</li> </ul> Sold separately. Use for SAC-NGTC5TC7-4SCHG.
<a href="#">CBL-TC5X-USBC2A-01</a>	USB C to USB A communications and charging cable, 1m long	<b>Sold separately. Use to:</b> <ul style="list-style-type: none"> <li>• Directly charge TC73 / TC78 using a wall wart.</li> <li>• Connect TC73 / TC78 to a computer (developer tools).</li> <li>• Charge TC73 / TC78 in a vehicle (can be used with cigarette light adapter <a href="#">SKU# CHG-AUTO-USB1-01</a>, if needed).</li> </ul>
<a href="#">CBL-TC2Y-USBC90A-01</a>	USB C to USB A cable with 90° bend in USB-C adapter	
<a href="#">25-124330-01R</a>	Micro USB active-sync cable. Allows for active-sync connectivity between the mobile computer single- or two-slot cradle and a host device.	<b>Sold separately.</b> Required for use with <a href="#">SKU# CRD-NGTC7-2SE1B</a> if syncing with a computer is desired while TC73 / TC78 is in the charger.
<a href="#">CBL-DC-523A1-01</a>	DC Y-line cord for running two spare battery chargers to a single Level VI power supply <a href="#">SKU# PWR-BGA12V108W0WW</a> .	<b>Sold separately. Use to:</b> Consolidate power supplies for multiple spare battery chargers proximally placed to each other.
<a href="#">PWR-WUA5V12W0XX</a>	USB type A power supply adapter (wall wart). Replace 'XX' in SKU as follows to get the right plug style based on region:  <b>US</b> (United States) • <b>GB</b> (United Kingdom) • <b>EU</b> (European Union) <b>AU</b> (Australia) • <b>CN</b> (China) • <b>IN</b> (India) • <b>KR</b> (Korea) • <b>BR</b> (Brazil)	<b>Sold separately.</b> Use with a communications & charge cable to directly charge TC73 / TC78 device drawing power from a wall socket.

**NOTE**  
Adapters and cables related to vehicle charging are listed later in this document.

# Accessories that power devices



## Power supply, cables, and adapters

### Power supply and cable matrix













SKU#	Description	Note
<a href="#">CBL-TC2X-USBC-01</a>	USB-A to USB-C cable with an additional ferrite bead.	
<a href="#">KIT-PWR-12V50W</a>	Power supply kit including Power Supply <a href="#">SKU# PWR-BGA12V50W0WW</a> and DC line cord <a href="#">SKU# CBL-DC-388A1-01</a> .	<b>Sold Separately:</b> Country-specific AC line cord.
<a href="#">CBL-DC-382A1-01</a>	DC line cord for running five-slot cradles when using Level VI Efficiency power supply <a href="#">SKU# PWR-BGA12V108W0WW</a> . Includes black extension tab for releasing the cable.	
<a href="#">CHG-AUTO-CLA1-01</a>	Cigarette lighter auto charger for vehicle cradle <a href="#">SKU# CRD-TC78-WCVC-01</a> .	
<a href="#">CHG-AUTO-HWIRE1-01</a>	Hard-wired auto charger cable for USB I / O Hub in vehicle cradle <a href="#">SKU# CRD-TC78-WCVC-01</a> .	<b>Sold separately.</b> Required for use with <a href="#">SKU# CRD-TC78-WCVC-01</a> to charge device.

# Accessories that power devices



## Power supply, cables, and adapters

### Country-specific AC line cords: grounded, 3-prong

SKU#	Country / region	Note	
<a href="#">23844-00-00R</a>	North America (United States, Canada, Mexico)	7.5 feet long Commonly used with chargers mounted in server racks	
<a href="#">50-16000-678R</a>	North America (United States, Canada, Mexico)	3 feet long	
<a href="#">50-16000-221R</a>	North America (United States, Canada, Mexico)	6 feet long	
<a href="#">50-16000-727R</a>	Brazil	1.8 meters (6 feet) long	
<a href="#">50-16000-680R</a>	Argentina	1.8 meters (6 feet) long	
<a href="#">50-16000-217R</a>	American Samoa, Australia, New Guinea	1.8 meters (6 feet) long	
<a href="#">50-16000-218R</a>	Japan	1.8 meters (6 feet) long	
<a href="#">50-16000-219R</a>	Antigua, Bermuda, Burma, Channel Islands, Hong Kong, Iraq, Ireland, Malaysia, North Ireland, Scotland, Singapore, United Kingdom, Wales	1.8 meters (6 feet) long	
<a href="#">50-16000-257R</a>	China	1.8 meters (6 feet) long	
<a href="#">50-16000-220R</a>	Europe, Abu Dhabi, Bolivia, Dubai, Egypt, Iran, Korea, Russia, Vietnam	1.8 meters (6 feet) long	
<a href="#">50-16000-671R</a>	Italy	1.8 meters (6 feet) long	
<a href="#">50-16000-669R</a>	India, S. Africa, Africa	1.8 meters (6 feet) long	

[Back to Table of Contents](#)

# Accessories that power devices



## Power supply, cables, and adapters

### Country-specific AC line cords: ungrounded, 2-prong

SKU#	Country / region	Note
<a href="#">50-16000-182R</a>	United States	Type A NEMA 1-15 plug
<a href="#">50-16000-255R</a>	Europe, Abu Dhabi, Bolivia, Dubai, Egypt, Iran, Korea, Russia, Vietnam.	Type C CEE7/16 plug
<a href="#">50-16000-670R</a>	Bermuda, England, Hong Kong, Iraq, Ireland, Malaysia, North Ireland, Scotland, Singapore, United Kingdom, Wales	
<a href="#">25-124330-01R</a>	Cradle to USB cable Single slot cradle to PC/host USB cable. <ul style="list-style-type: none"><li>• Used with single-slot cradle.</li><li>• Micro-USB connection on cradle end</li></ul>	



## Vehicle chargers and accessories



### Wireless charger for use in vehicles

SKU# CRD-TC78-WCVC-01

TC78 Wireless charger for vehicles.

- Can be mounted using four AMPS-pattern holes.
- Includes a holder for stylus that can be installed either to the left or right of device in cradle or removed.
- Requires: TC78 device with wireless battery [SKU# BTRY-NGTC5TC7-44MAWC-01](#). All sold separately.
- Required to charge: Cigarette lighter adapter auto charge cable [SKU# CHG-AUTO-CKA1-01](#) OR hard-wired auto charge cable [SKU# CHG-AUTO-HWIRE1-01](#).
- For power and mounting options: see [Vehicle Holders and Mounts](#) listed later in this document.

Compatibility	
TC73	No
TC78	Yes



### Vehicle holder

SKU# CRD-TC7NG-NCCD-01

Non-powered vehicle holder.

- Holds device in vehicle installations.
- Spring tension on holder, so does not support Pistol Grip Handle.
- Compatible with B and C size RAM® 2-hole diamond bases.
- Provides access to USB-C port on bottom of device allowing device to be charged.
- Available for mounting using [SKU# RAM-B-166U](#).

Compatibility	
TC73	Yes
TC78	Yes

#### NOTE

For mounting options and non-powered vehicle holders, please see section titled, "[Vehicle Holders and Mounts](#)", in this document.

For charging cables that can be used with vehicle holders, please see section titled, "[Power Supply, Cables, and Adapters](#)", in this document.

# Accessories that enable productivity solutions



## Vehicle holders and mounts



### Cigarette lighter adapter plug

SKU# CHG-AUTO-USB1-01

USB cigarette lighter adapter plug.

- Used with USB Type C Cable SKU# CBL-TC5X-USBC2A-01 to charge device.
- Includes two USB Type A ports providing higher current (5V, 2.5A) for faster charging.



### Vehicle mounting hardware

SKU# RAM-B-166U

Vehicle cradle windshield suction cup mount.

- RAM twist lock suction cup with double socket arm and diamond base adapter.
- Overall length: 6.75".
- Attaches to back of vehicle cradles.



### Vehicle cradle mount ball

SKU# RAM-B-238U

Vehicle cradle RAM mount ball.

- RAM 2.43" x 1.31" diamond ball base with 1" ball.
- Attaches to back of vehicle cradles.

[Back to Table of Contents](#)

# Accessories that enable productivity solutions



## Headsets

### Rugged Bluetooth HD voice headsets for the most demanding industrial environments

When it comes to enabling speech-driven applications and voice communications in warehouses, manufacturing plants and outdoor yards, you need a headset that is specially designed for the job. The HS3100 Bluetooth headset is loaded with features that offer everything you need in an industrial headset.

[Learn more about how these headsets deliver a superior voice experience.](#)



#### Wireless headsets for voice-directed picking HS3100 rugged Bluetooth headset

Bluetooth headset for voice-directed picking applications.

- Noise cancellation tuned for Voice-Directed Picking applications.
- Swap batteries on the fly — without losing the Bluetooth connection.
- Split-second tap-to-pair simplicity using NFC. 15 hours of battery power.

SKU#	Description
<a href="#">HS3100-OTH</a>	HS3100 Rugged Bluetooth Headset Over-The-Head Headband includes HS3100 Boom Module and HSX100 OTH Headband Module
<a href="#">HS3100-BTN-L</a>	HS3100 Rugged Bluetooth Headset (Behind-the-neck headband left)
<a href="#">HS3100-OTH-SB</a>	HS3100 Rugged Bluetooth Headset (Over-the-head headband) includes HS3100 Shortened Boom Module and HSX100 OTH headband module
<a href="#">HS3100-BTN-LSB</a>	HS3100 Rugged Bluetooth Headset (Behind-the-neck headband left) includes HS3100 Shortened Boom Module and HSX100 BTN headband module
<a href="#">HS3100-SBOOM-01</a>	HS3100 Shortened Boom Module (includes microphone boom, battery and windscreen)

## Close gaps, Open possibilities with Workforce Connect

Usher in a new era of transformation—one led by your frontline and powered by Zebra Workforce Connect. One where communication and information flows freely and gaps between teams, workflows and data are closed.

With Workforce Connect, hindered workers become effective problem solvers, contributing their best. Critical workflows are streamlined in one place, on one device, equipping workers with the information they need, right at their fingertips.

Only Zebra offers the most complete lineup of software and rugged hardware with the scalability, support and service needed to make the greatest impact where it counts—on the frontline.

[Learn more about you can elevate your frontline workers with Zebra Workforce Connect.](#)



#### Wired headset for Workforce Connect

SKU# [HDST-USBC-PTT1-01](#)

PTT headset with USB-C connector; one-piece solution.

- For Push-To-Talk (PTT) applications with volume up / volume down / PTT buttons. Compatible with PTT Express / PTT Pro.
- Rotating earpiece allows for right or left ear configuration. Mono headset with microphone.
- Includes clip for attaching PTT button to clothing.

Compatibility	
TC73	Yes
TC78	Yes

[Back to Table of Contents](#)



# Accessories that enable productivity solutions



## Hand strap, stylus and tether



### Hand strap

SKU# SG-NGTC5TC7-HDSTP-03

Hand strap

- Allows device to be easily held in palm of hand.
- Attaches directly to device
- Includes loop for holding optional stylus.
- Also available as a 3-pack — 3 hand straps— SKU# SG-NGTC5TC7-HDSTP-03.



### Stylus

SKU# SG-STYLUS-TCX-MTL-03

Fiber tipped stylus – pack of 3.

- Heavy-duty and made from stainless steel / brass. No plastic parts — real pen feel. Can be used in rain.
- Micro-knit, hybrid-mesh, fiber tip provides silent, smooth gliding use. 5" length.
- Big improvement over rubber tipped or plastic tipped stylus.
- Compatible with all capacitive touch screen devices.
- Tether to device or hand strap using SKU# SG-TC5NGTC7NG-TETHR-03.



### Stylus tether

SKU# SG-TC5NGTC7NG-TETHR-03

Stylus tether – pack of 3.

- Can be attached to device tower bar.
- When hand strap is used, tether should attach to hand strap SKU# SG-NGTC5TC7-HDSTP-03 directly (not to terminal towel bar).
- String type tether prevents loss of stylus.
- NOTE: Other Zebra coiled tethers are not recommended for use with TC73 / TC78 as they may interfere with other accessories.

[Back to Table of Contents](#)

## Electronic trigger handles and accessories



### Electronic trigger handle

SKU# TRG-NGTC7-ELEC-01

Pistol-grip trigger handle.

- Uses electrical trigger via contacts on back side of TC73 / TC78.
- Trigger handle accessory offers customers the option of using the product in a gun form factor, ideal for scan-intensive situations.
- Does not block access to rear facing camera and flash allowing camera to be used while using the trigger handle.
- Compatible with both standard and extended capacity batteries.
- Sold separately: Optional wrist strap [SKU# SG-PD40-WLD1-01](#).



### Trigger handle wrist strap

SKU# SG-PD40-WLD1-01

Looping wrist strap for trigger handle.

- Attaches to bottom of pistol-grip trigger handle.

# Accessories that protect devices



## Soft holster, and screen protectors



### Soft holster

SKU# SG-NGTC5TC7-HLSTR-01

Soft holster.

- Vertical orientation with open bucket design to accommodate TC73 / TC78 pistol-grip trigger handle, and/or hand strap.
- Strap on rear of holster allows adjustment for use with the accessory options mentioned above.
- Includes loop for storage of optional stylus. Nonrotating for maximum durability.
- Holster is leather material and includes cut-out for speaker output.
- Also compatible with trigger handle [SKU# TRG-NGTC7-ELEC-01](#).



### Screen protectors

SKU# SG-NGTC7-SCRNP-03

Screen protector – pack of 3.

- Tempered glass.
- Includes alcohol wipes, cleaning cloth, and instructions needed for screen protector installation.

## TC73 / TC78 Workstation Connect Cradle

Introducing the new **Workstation Connect Cradles** for TC73 / TC78 mobile computers. This accessory allows for the TC73 / TC78 mobile computer to connect to multiple purpose-built peripherals and enable Zebra Workstation Connect on an external monitor. The Connect Cradle offers connections for standard workstation setups (monitor, keyboard, mouse).



**SKU# CRD-NTC7X-1SNWS-01**

Workstation

- Workstation: TC73 / TC78 Connect Cradle, allows to connect a mobile computer to an external monitor and multiple peripherals. Includes HDMI, Ethernet and USB-A (x4) ports.

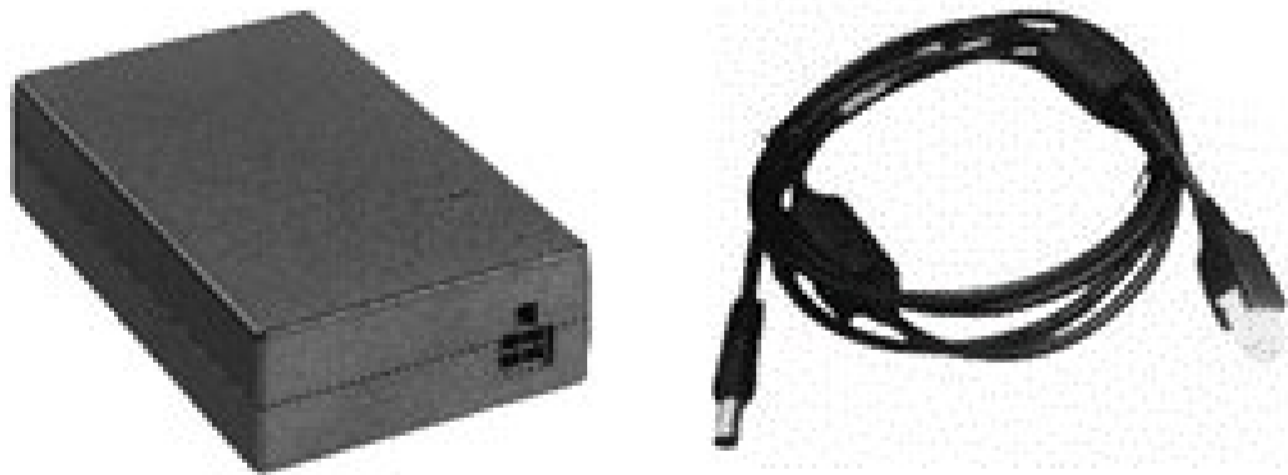

**SKU# PWR-BGA12V50W0WW | SKU# CBL-DC-388A2-01**

Power Supply | DC Line Cord

- Power Supply [PWR-BGA12V50W0WW](#) for Connect Cradle : 100-240 VAC, 12VDC, 4.16A.
- DC Line Cord [CBL-DC-388A2-01](#) for above power supply: 12 VDC, 4.16A 1.8m length.

## Third Party Accessories for TC73 and TC78

**Note:** Products sold that do not bear the Zebra brand name are serviced and supported exclusively by their manufacturers in accordance with terms and conditions packaged with the products. Zebra's Limited Warranty does not apply to products that are not Zebra branded, even if packaged or sold with Zebra products. Please contact the manufacturer directly for technical support and customer service.

[Back to Table of Contents](#)



**ZEBRA**

**TC73/TC78**

**PROCLIP CRADLES PROVIDE:**

- Easy one-handed docking and undocking
- Tilt-swivel gives users an optimized viewing angle
- Channeled sidewalls guide the device into the cradle and hold the device securely
- Heavy-duty construction provides protection and longevity
- Custom design to fit the device with or without the rugged boot

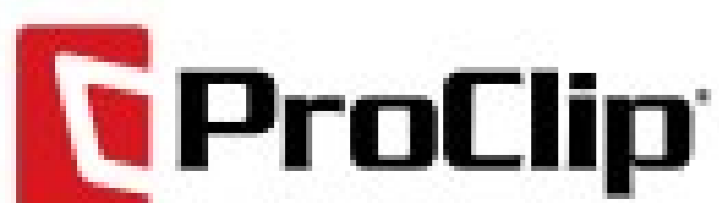
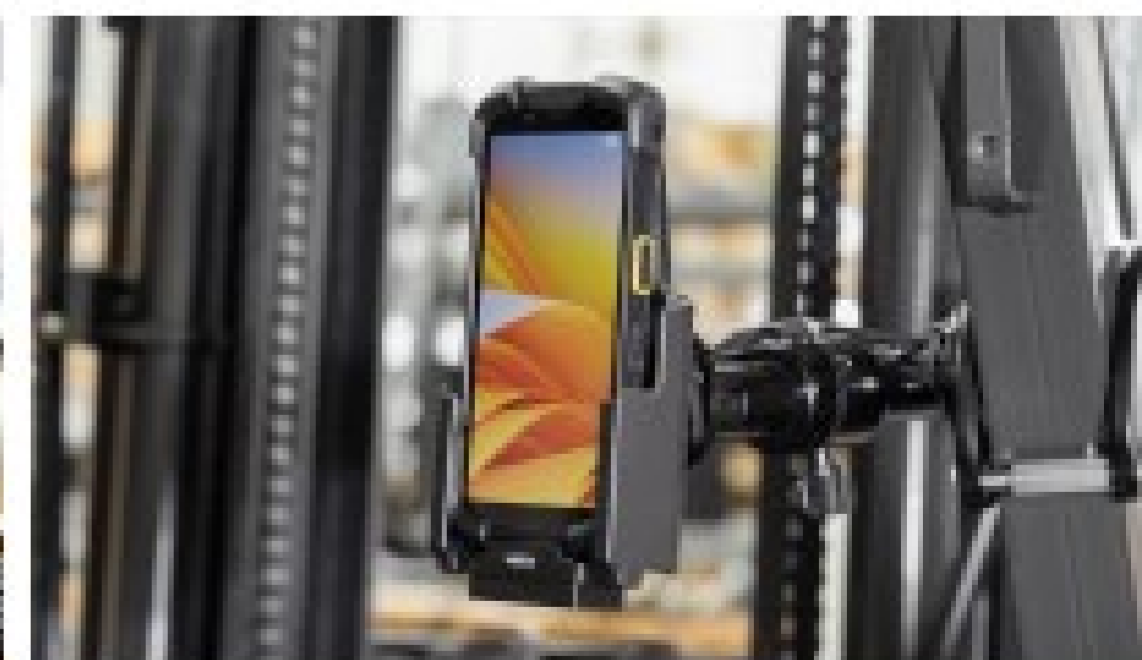

North America: [ProClipUSA.com](http://ProClipUSA.com)  
Europe: [Brodit.com](http://Brodit.com)





PART #	DESCRIPTION
3PTY-PCLIP-712310	Charging Cradle with Tilt Swivel and Cigarette Lighter Adapter for Zebra TC73 / TC78



PART #	DESCRIPTION
3PTY-PCLIP-713310	Charging Cradle with Tilt Swivel and Hard-Wired Power Supply for Zebra TC73 / TC78 (Modular Backplate for Attachment of Key Lock Module)



PART #	DESCRIPTION
3PTY-PCLIP-712354	Charging Cradle with Top Support, Tilt Swivel and Cigarette Lighter Adapter for Zebra TC73 / TC78



PART #	DESCRIPTION
3PTY-PCLIP-713354	Charging Cradle with Top Support, Tilt Swivel and 5.4V Hard-Wired Power Supply for Zebra TC73 / TC78

ZEBRA

TC73/TC78



PART #	DESCRIPTION
3PTY-PCLIP-216448	Charging Cradle with Integrated Power Supply on Back and Barrel Jack Connection to the Legacy TC7X Power Cable for Zebra TC73 / TC78

ADDITIONAL MOUNTING OPTIONS

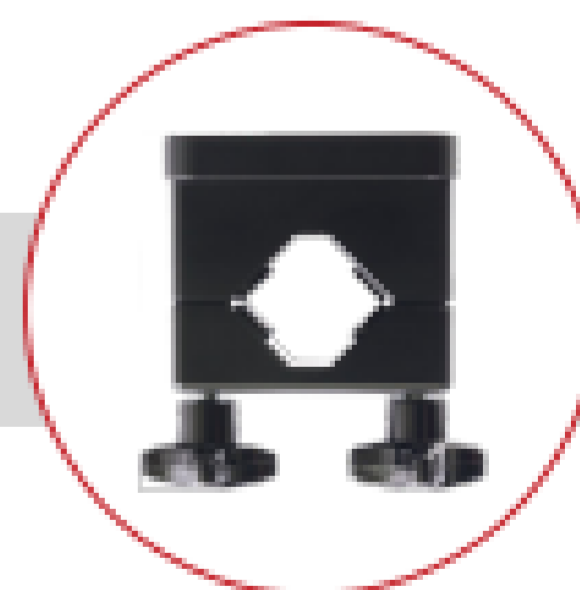





# RAM® Form-Fit Docks

## for Zebra TC73 / TC78 Handheld Computers

Rugged accessories meet rugged devices with these RAM® Handheld PC docks for the Zebra TC73 & TC78. These form-fitting docks are available with and without power, as well as non-locking and key-locking functions. Powered dock options offer a seamless experience by utilizing the device's pogo pad docking contacts and 5.5mm DC barrel connector — simply dock the device to keep it charging.



Zebra TC73 / TC78 RAM® Mounts Docks

PART NUMBER	KEY LOCK	DC POWER
3PTY-RAM-HOL-ZE17-1U		•
3PTY-RAM-HOL-ZE17L-1U	•	•
3PTY-RAM-HOL-ZE17-NP-1U		
3PTY-RAM-HOL-ZE17L-NP-1U	•	

### COMPATIBLE HARDWARE CHARGERS



**3PTY-RAMGDSCHARGEM55V7B1U**  
GDS® 10-30V Hardwire Charger

**3PTY-RAM-GDSCHARGEM55V8BU**  
GDS® 30-64V Hardwire Charger

## Product Highlights



### Pogo Pin Charging

Protect the charge port and increase efficiency utilizing the device's pogo pad docking contacts — simply dock the TC73/TC78 to keep the device charged. Each powered RAM® dock comes equipped with pogo pin technology for this seamless docking experience.



### Stylus Holder

Integrated snap-in stylus holder on all docks prevent lost or dangling styluses when on-the-go.



### Mount It

With RAM® Compatibility™ customize your mount to your environment, or pair with these ready-made forklift kits.

**3PTY-RAM-102U-B-247**  
C-Size Heavy Duty Forklift Mount

**3PTY-RAM-B-102U-247**  
B-Size Light Duty Forklift Mount