



# RFID Inlay Placement/Power Guidelines

www.zebra.com/transponders

Zebra RZ400

Model Number: RZ400-XXXX-XXXRX

Revision Date: 2-Dec-15

This document defines the optimal encode position for RFID inlays when used with Zebra Printer/Encoders. These guidelines are provided for two purposes.

1. To define the optimal inlay position (x), minimum inlay pitch (y), and encoder power setting for RFID media **without use of the program position command**. Media converted to these guidelines require **no RFID calibration step**, and no extra media movement for RFID encoding. This is the optimal method to print and encode RFID media.
2. For media converted to a compatible inlay pitch (y), but different inlay position (x), these guidelines should be used to determine the required inlay program position. Program position is set by parameter "p" of the ^RS command. This can be useful for encoding directly to wet inlays, or for using media converted to a different inlay position.

Three critical dimensions define transponder placement and pitch, as shown in the schematic to the right and explained below.

Parameter	Name	Definition	Explanation
<b>a (mm)</b>	Inlay Center	Left liner edge to inlay center Viewed from face stock side, feed direction down	RF coupling with the inlay can change horizontally across the width of the label. This dimension is relative to the inlay <i>antenna center</i> , which is not always the same as the chip location. "a" is typically defined with a $\pm 3\text{mm}$ tolerance.
<b>x (mm)</b>	Inlay Position	Label Start to inlay antenna leading edge	This dimension ensures proper RF coupling with the inlay in the current label. It is relative to the inlay <i>antenna leading edge</i> . This is also the optimal distance from the printline to inlay antenna during encoding. "x" is generally given with a $\pm 3\text{mm}$ tolerance.
<b>y (mm)</b>	Inlay Pitch	Distance from inlay antenna leading edge to inlay antenna leading edge.	If Inlays are spaced too close together, coupling to multiple inlays can sometimes occur. This dimension ensures coupling with only the inlay in the current label. "y" defines the <i>minimum pitch</i> required to avoid multiple coupling.

**Example 1: Determine the optimal converting position for an Avery AD-223 Inlay in a 4"x2" label with 1/8" gap for the R110Xi UHF to be used in Region 0.** The guideline specifies a=51mm, x=34mm, y 51mm. Since the label + gap length, 2.125", is greater than "y", inlay pitch is compatible with the guideline. The leading edge of the inlay antenna should be placed 34mm from the "Label Start". In this case, "Label Start" is the leading edge of the label.

**Example 2: Determine the program position for a Raflatrac Short Dipole #3001490 converted to a=50mm, x=2mm, y=20mm for the RZ400 UHF to be used in Region 0.** The guideline specifies a=51mm, x=13mm, y 20mm. In this case, "a" and "y" are compatible with the guideline, but "x" is not. To encode the inlay, the label needs to move *backward* into the printer by a distance of: 13mm - 2mm = 11mm. This can be accomplished by setting parameter "p" of the ^RS command to "B11". Program position capabilities vary by printer model and firmware version. See the Zebra RFID Programming Guide and firmware release notes for more information.







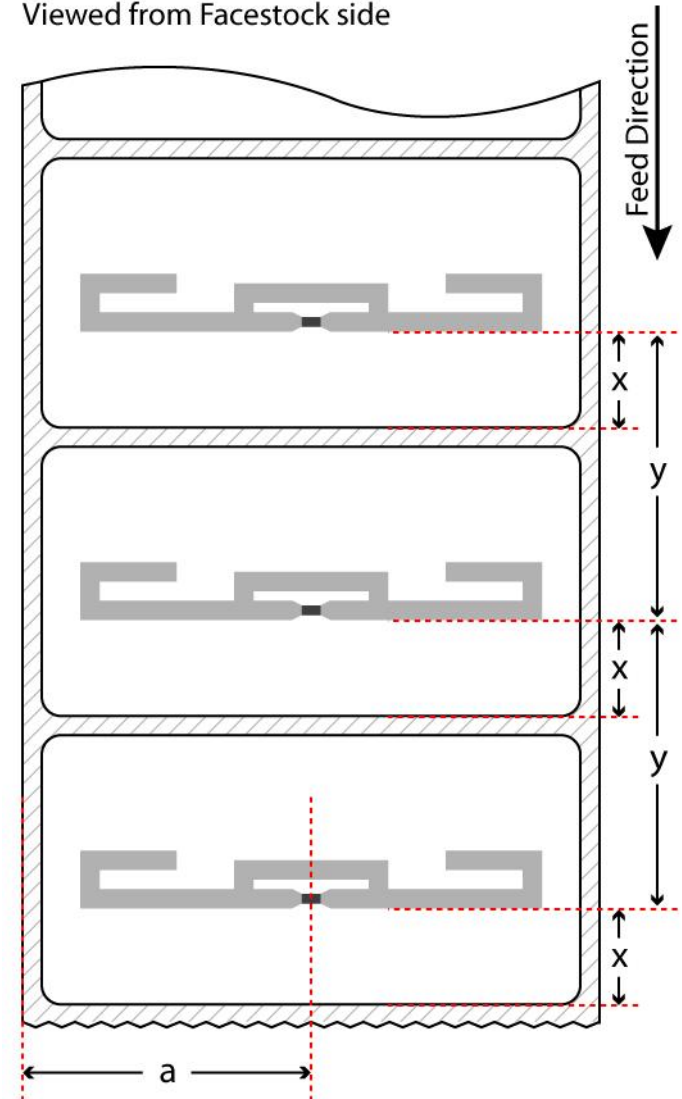

**Note:**







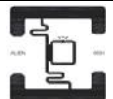

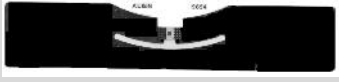

- Guidelines are only valid for the specified printer model and region.
- Many inlays look similar, but behave very differently. Guidelines are only valid for the specific inlay listed.
- Inlay orientation is critical. Images are shown as viewed through the media face stock, with feed direction down.
- For media compliant to the guidelines below, do not run the printer RFID calibrate procedure.
- "Label Start" is defined by one of three different methods: 1) The leading edge of a label, 2) The leading edge of a black mark, or 3) The leading edge of a notch (See printer specifications for mark and notch requirements).
- Because "y" is defined as a minimum distance, for some inlays "y" can actually be smaller than "x". In this case, a program position is required to run the media at the minimum pitch.
- Inlay pitch, "y", is not always equal to the label length + 1/8" gap. In some cases, labels are converted with a larger gap, to accommodate the minimum pitch requirement.
- Guidelines are established using the latest printer firmware. See www.zebra.com for firmware updates.











Viewed from Facestock side









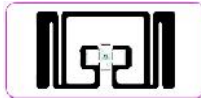













DISCLAIMER: THE INFORMATION CONTAINED IN THIS GUIDELINE IS SUBJECT TO THE WARRANTY DISCLAIMERS, LIMITATIONS OF LIABILITY AND INDEMNIFICATION PROVISIONS CONTAINED IN THE ZEBRA TECHNOLOGIES CORPORATION INLAY GUIDELINES TERMS OF USE. SUCH TERMS OF USE MAY BE FOUND AT WWW.ZEBRA.COM/TRANSPONDERS









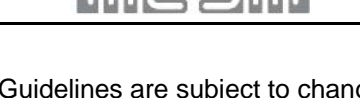

Date	Manufacturer	Part #	Inlay Orientation (Size not to scale)	All Regions				
				Position (mm)			Power	
				a (±3)	x (±3)	y (≥)	Read	Write
8/10/11	Alien	ALN-9610		28	11	16	21	22
8/10/11	Alien	ALN-9610		28	11	16	21	22
9/13/11	Alien	ALN-9613		13	10	20	26	26
3/22/12	Alien	ALN-9627		19	9	51	15	20
8/17/09	Alien	ALN-9629		19	0	32	18	26
12/1/10	Alien	ALN-9630		35	11	16	16	19
12/1/10	Alien	ALN-9630		35	13	16	16	19
3/31/09	Alien	ALN-9634 ALN-9634-F		25	5	54	20	25
12/1/11	Alien	ALN-9640 ALN-9640-F		51	20	16	12	18
3/31/09	Alien	ALN-9640 ALN-9640-F		51	14	16	18	21

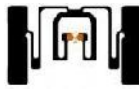









Date	Manufacturer	Part #	Orientation (Size not to scale)	All Regions				
				Position (mm)			Power	
				a (±3)	x (±3)	y (≥)	Read	Write
8/19/09	Alien	ALN-9654 ALN-9654-F		51	9	25	18	23
4/19/11	Alien	ALN-9662 ALN-9662-F		40	8	25	23	27
4/19/11	Alien	ALN-9662 ALN-9662-F		40	8	25	23	27
2/6/13	Alien	ALN-9710		25	13	20	18	20
2/6/13	Alien	ALN-9710		25	22	16	18	19
7/715	Alien	ALN-9713 SIT		17	12	25	15	19
4/3/14	Alien	ALN-9715 Glint		17	12	16	27	26
2/13/13	Alien	ALN-9720		25	10	22	22	23
4/1/13	Alien	ALN-9728 GT H4		25	12	38	10	25
4/1/13	Alien	ALN-9728 GT H4		25	7	54	12	25
7/12/12	Alien	ALN-9730		38	13	16	22	24

Date	Inlay			All Regions				
				Position (mm)			Power	
				a (±3)	x (±3)	y (≥)	Read	Write
Manufacturer	Part #	Orientation (Size not to scale)						
7/12/12	Alien	ALN-9740		51	14	16	20	23
3/20/13	Alien	ALN-9745		52	23	16	10	12
7/12/12	Alien	ALN-9762		38	8	25	16	22
7/21/14	Alien	ALN-9768 Wonderdog		47	8	55	12	17
4/1/13	Alien	ALN-9770 Battery H4		52	4	38	20	20
10/5/12	Arizon	E41		51	23	20	8	12
10/1/12	Arizon	E41		51	14	20	18	18
12/20/11	Avery	AD-110m5		13	16	25	15	18
12/14/12	Avery	AD-171		25	9	38	11	12
12/14/12	Avery	AD-171 Jewelry		51	9	38	13	16
12/2/13	Avery	AD-172u7		19	9	38	15	15











Date	Inlay			All Regions				
				Position (mm)			Power	
				a (±3)	x (±3)	y (≥)	Read	Write
Manufacturer	Part #	Orientation (Size not to scale)						
12/2/13	Avery	AD-172u7		19	9	38	15	15
3/31/09	Avery	AD-223		51	24	16	15	15
3/31/09	Avery	AD-223		51	13	16	21	21
9/30/09	Avery	AD-224		51	23	16	18	18
9/30/09	Avery	AD-224		51	12	16	24	24
5/23/11	Avery	AD-226		51	23	16	13	23
5/23/11	Avery	AD-226		51	12	16	13	23
11/5/13	Avery	AD-227		51	12	16	20	20
9/19/12	Avery	AD-227		51	14	16	16	18
8/24/09	Avery	AD-230		38	14	22	18	18
8/24/09	Avery	AD-230		38	7	22	18	18





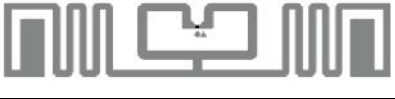





Date	Manufacturer	Part #	Inlay Orientation (Size not to scale)	All Regions				
				Position (mm)			Power	
				a (±3)	x (±3)	y (≥)	Read	Write
2/9/11	Avery	AD-231		38	12	19	12	15
2/9/11	Avery	AD-231		38	5	19	18	18
3/14/11	Avery	AD-232		38	18	22	18	21
3/14/11	Avery	AD-232		38	18	22	18	21
10/29/12	Avery	AD-233D		38	9	22	12	12
10/29/12	Avery	AD-233S		38	9	22	12	12
9/23/09	Avery	AD-240		51	21	16	18	20
6/15/13	Avery	AD-317iL		25	6	38	18	20
1/8/14	Avery	AD-318m5		25	19	38	15	17
1/9/14	Avery	AD-319em		38	6	26	15	22
8/19/15	Avery	AD-319em		38	7	26	12	25











Date	Manufacturer	Part #	Inlay Orientation (Size not to scale)	All Regions				
				Position (mm)			Power	
				a (±3)	x (±3)	y (≥)	Read	Write
7/22/13	Avery	AD-370u7		25	4	64	10	12
4/25/11	Avery	AD-380		38	7	51	9	18
4/25/11	Avery	AD-380		38	4	51	16	18
7/11/12	Avery	AD-380WiL		25	7	51	9	19
12/14/12	Avery	AD-550		25	4	95	30	30
2/4/10	Avery	AD-641		51	17	79	20	22
11/30/09	Avery	AD-805		12	20	25	18	18
11/11/13	Avery	AD-806u7		16	9	26	12	12
11/11/13	Avery	AD-806u7		16	20	26	12	12
8/19/09	Avery	AD-814		13	20	38	12	12
9/23/09	Avery	AD-815		12	12	19	18	20

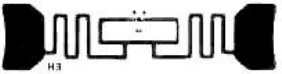









Date	Inlay			All Regions				
				Position (mm)			Power	
				a (±3)	x (±3)	y (≥)	Read	Write
Manufacturer	Part #	Orientation (Size not to scale)						
8/17/09	Avery	AD-824		19	5	63	15	18
8/19/09	Avery	AD-826		19	4	63	18	21
8/19/09	Avery	AD-827		13	7	51	17	20
11/30/09	Avery	AD-828		12	17	44	18	20
3/31/09	Avery	AD-843		51	6	44	15	15
10/21/13	CCRR	CCRR - E52		40	12	23	15	15
8/20/12	CGP, Inc	MAZE G2iL		51	11	28	12	18
8/20/12	CGP, Inc	MAZE G2iL		51	6	28	16	20
8/20/12	CGP, Inc	MAZE M5		51	11	28	8	10
8/20/12	CGP, Inc	MAZE M5		51	6	28	17	17
8/4/11	Checkpoint	Case & Pallet		52	9	38	20	22









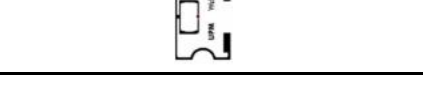









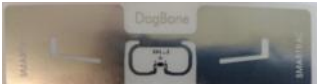

Date	Manufacturer	Part #	Orientation (Size not to scale)	All Regions				
				Position (mm)			Power	
				a (±3)	x (±3)	y (≥)	Read	Write
1/30/13	Checkpoint	Champion M5		38	8	25	15	18
6/11/12	Checkpoint	Champion II		38	6	32	12	12
8/19/11	Checkpoint	Hi-Kick		20	6	43	9	20
8/11/11	Checkpoint	Hi-Kick		20	11	43	10	20
7/20/10	Checkpoint	MV-Champion 74X23		38	5	30	15	15
8/5/11	Checkpoint	Triumph		38	7	22	21	23
8/5/11	Checkpoint	Triumph		38	10	22	15	20
5/29/14	Checkpoint	Triumph -2		37	7	25	10	16
8/19/11	Checkpoint	Whirl		25	18	27	8	10
8/11/11	Checkpoint	Whirl		25	18	27	12	16
1/30/13	Checkpoint	Wind Apparel M5		25	4	40	10	10



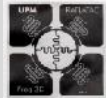

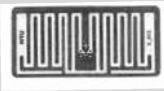
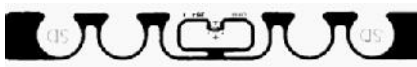

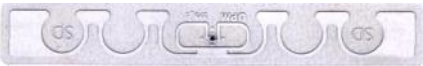



Date	Inlay			All Regions				
				Position (mm)			Power	
				a (±3)	x (±3)	y (≥)	Read	Write
Manufacturer	Part #	Orientation (Size not to scale)						
1/30/13	Checkpoint	Wind Sporting M5		25	4	40	10	10
8/27/13	Checkpoint	ZEPHYR		30	1	40	15	19
7/17/20	Checkpoint	Zepher-2		30	11	40	10	15
11/5/09	Confidex	3000104		46	13	28	15	15
12/2/13	Confidex	SilverLine M4QT FCC		49	4	49	11	13
12/2/13	Confidex	SilverLine M4QT FCC		49	14	49	19	21
12/2/15	Confidex	Silverline Slim		57	16	30	17	20
6/3/15	CustomWave	CW-100-08MR6			3	35	12	18
4/12/12	IER	ID-6071		38	3	40	15	20
7/11/14	Impinj	TH41 Cabis		16	9	40	14	18
4/1/13	Invengo	8013-C13 Bullet M5		25	7	23	19	20









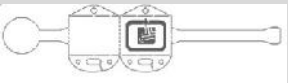

Date	Manufacturer	Part #	Inlay Orientation (Size not to scale)	All Regions				
				Position (mm)			Power	
				a (±3)	x (±3)	y (≥)	Read	Write
4/1/13	Invengo	8024-13 Butterfly M5		25	4	36	20	20
4/26/11	Invengo	8024-C06 Apparel M4		38	7	38	20	20
3/14/11	Invengo	8029-C06 Apparel M4		38	7	22	18	18
1/12/12	Invengo	8029-C07+FSI xWing H3		38	8	22	17	17
7/17/13	Invengo	8029-C13 Xwing M5		25	4	36	16	16
1/12/12	Invengo	8029-C13+FSI xWing M5		38	8	22	17	17
3/5/09	Invengo	8030A		51	7	25	24	24
1/12/12	Invengo	8030-B-C13+FSI Great Wall M5		51	13	20	17	17
3/14/11	Invengo	8032-C08 Apparel		38	6	22	18	22
4/1/13	Invengo	8038-C09 Shamrock M4		32	7	62	16	17
4/1/13	Invengo	8102-C12 Library G2iM		52	22	21	10	18

Date	Inlay			All Regions				
				Position (mm)			Power	
				a (±3)	x (±3)	y (≥)	Read	Write
Manufacturer	Part #	Orientation (Size not to scale)						
12/14/11	Invengo	8108-C06 Jewelry		51	14	15	24	24
9/26/14	Invengo	XCTF-8039-C13 Scorpion		15	16	21	19	22
8/8/13	MAINtag	FLYtag		53	10	19	20	20
10/15/12	Omni-ID	IQ-400		51	Forward 15	65	26	28
10/15/12	Omni-ID	IQ-600		51	1	83	20	20
1/8/15	Omni-ID	IQ-800		54	8	25	10	15
11/18/10	Sirit	RSI-674		51	14	16	18	18
12/22/10	Sirit	RSI-675		30	21	22	14	16
3/31/09	SMARTRAC	ShortDipole M3		51	13	20	18	18
3/31/09	SMARTRAC	ShortDipole M3		51	20	20	15	15
5/16/12	SMARTRAC	WEB G2iL		19	6	60	15	21



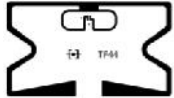

Date	Manufacturer	Part #	Inlay Orientation (Size not to scale)	All Regions				
				Position (mm)			Power	
				a (±3)	x (±3)	y (≥)	Read	Write
1/7/13	SMARTRAC	WebLite M5		25	9	20	18	18
4/26/11	SMARTRAC	Belt M5		38	13	20	20	20
4/26/11	SMARTRAC	Belt M5		38	7	20	20	20
1/27/11	SMARTRAC	Belt G2iL		38	9	30	18	18
1/27/11	SMARTRAC	Belt G2iL		38	9	30	18	18
3/1/13	SMARTRAC	Belt M3		38	11	20	20	20
3/1/13	SMARTRAC	Belt M3		38	9	20	15	15
2/17/09	SMARTRAC	Dogbone M3		51	14	30	18	18
8/22/11	SMARTRAC	Dogbone G2iL		51	1	30	15	20
7/14/15	SMARTRAC	Dogbone DNA Gen2V2		50	14	30	18	19
4/20/10	SMARTRAC	Dogbone M4		51	14	30	15	15

Date	Manufacturer	Part #	Orientation (Size not to scale)	All Regions				
				Position (mm)			Power	
				a (±3)	x (±3)	y (≥)	Read	Write
9/7/10	SMARTRAC	E42 M4		38	12	25	12	12
8/19/09	SMARTRAC	Frog M3		38	18	80	18	18
1/11/13	SMARTRAC	Frog 3D M4 3X3		38	4	80	15	17
11/9/10	SMARTRAC	Frog 3D M4		28	9	60	9	15
12/16/13	SMARTRAC	Mini Paper		15	20	30	15	15
1/25/12	SMARTRAC	MiniWeb G2iL		25	5	24	12	23
6/8/12	SMARTRAC	ShortDipole M5		51	11	20	16	19
9/26/11	SMARTRAC	ShortDipole M4		51	20	20	12	12
9/26/11	SMARTRAC	ShortDipole M4		51	13	20	15	15
12/7/11	SMARTRAC	ShortDipole G2iL		51	11	20	16	20
6/1/12	SMARTRAC	ShortDipole G2iM		51	11	20	16	20

Date	Manufacturer	Part #	Orientation (Size not to scale)	All Regions				
				Position (mm)			Power	
				a (±3)	x (±3)	y (≥)	Read	Write
8/17/09	SMARTRAC	Spine M3		51	23	20	9	12
1/4/13	SMARTRAC	Trap M4		13	16	32	20	20
3/1/12	SMARTRAC	Trap M5		13	16	32	15	22
3/31/09	SMARTRAC	Web M3		13	9	48	27	27
5/25/11	SMARTRAC	Web M4		25	7	40	15	18
11/7/12	SMARTRAC	Web M5		30	3	40	11	15
7/22/13	SMARTRAC	WEB NPX U-Code G2iL		30	4	40	12	23
4/22/14	SML	GB2U		41	15	25	23	25
4/22/14	SML	MAZE G2il		50	11	25	10	15
4/22/14	SML	MAZE M5		50	10	25	10	12
12/14/12	TAGEOS	EOS-100		51	11	30	14	14

Date	Manufacturer	Part #	Orientation (Size not to scale)	All Regions				
				Position (mm)			Power	
				a (±3)	x (±3)	y (≥)	Read	Write
12/14/12	TAGEOS	EOS-300		25	20	30	16	20
3/1/13	TAGEOS	EOS-400		38	10	25	16	20
4/22/14	TAGEOS	EOS-400 UCODE 7		39	17	25	13	16
4/22/14	TAGEOS	EOS-400 UCODE 7		39	9	25	16	19
11/30/13	TAGEOS	EOS-500		51	18	30	20	23
7/11/14	Trace Tech ID Solutions	T5030-IL		22	6	62	10	20
9/18/13	Trace Tech ID Solutions	TE14 THINPROPELLER		55	21	17	16	16
5/27/14	Trace Tech ID Solutions	TE14 THINPROPELLER		55	13	28	11	14
2/12/14	Trace Tech ID Solutions	TE25 Apparel		43	9	20	20	20
7/11/14	Trace Tech ID Solutions	TE35 Gain		52	8	30	10	11
7/11/14	Trace Tech ID Solutions	TF44		43	3	34	10	20

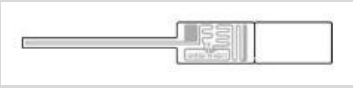
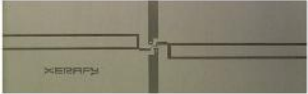

Date	Inlay			All Regions				
				Position (mm)			Power	
	Manufacturer	Part #	Orientation (Size not to scale)	a (±3)	x (±3)	y (≥)	Read	Write
7/11/14	Trace Tech ID Solutions	TH41 Cabis		26	6	40	12	14
7/17/14	Trace Tech ID Solutions	TH41 Cabis		16	9	40	14	18
3/13/13	UBIQUE.TAG	UBIK-826		38	16	20	22	25
8/26/13	XERAFY	Metal Skin G1+		54	0	42	27	27
8/26/13	XERAFY	Metal Skin Mercury		45	0	42	27	27